



MACHINES THAT TRANSFORM IDEAS INTO REALITY



BENDING | DRILLING | CUTTING | WELDING | TECHNOLOGY

PBM BENDING WORKS



SBM & PRM BENDING WORKS



ARM BENDING WORKS



PRESSBRAKE BENDING WORKS

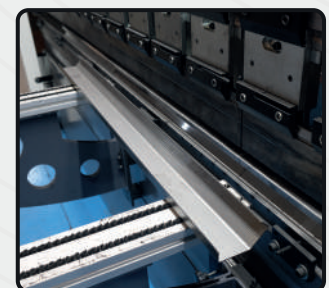
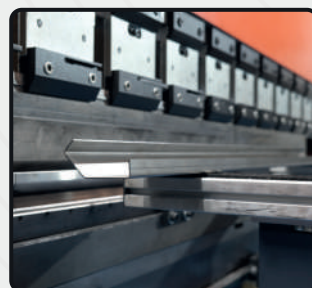
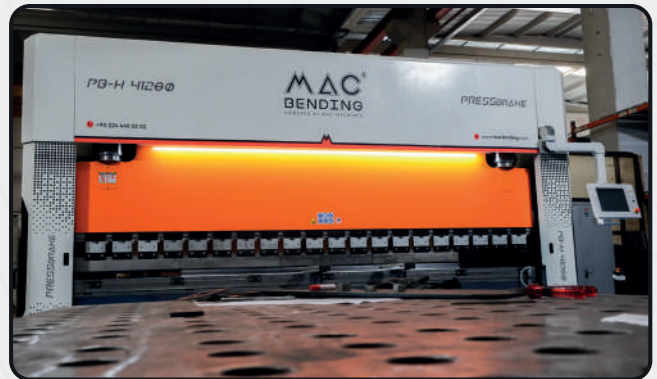

PRODUCTION PROCESS



DRL-B3 DRILLING WORKS



DRL-F 1500 DRILLING WORKS



PBM SERIES

BROWSE THE
CATALOG BY
SCANNING THE
QR CODE.



PBM MEDIUM SERIES

HYDRAULIC PROFILE AND
PIPE BENDING MACHINE



PBM HEAVY SERIES

HYDRAULIC PROFILE AND
PIPE BENDING MACHINE

BROWSE THE
CATALOG BY
SCANNING THE
QR CODE.



ARM SERIES

ARM MINI & ECONOMIC SERIES

HYDRAULIC PROFILE AND
PIPE BENDING MACHINE



PB-H PRESSBRAKE SERIES



SBM SERIES

BROWSE THE
CATALOG BY
SCANNING THE
QR CODE.



SBM-4L
LINEAR SYSTEM



SBM-4P
PLANETARY SYSTEM



SBM-3V
VARIABLE GEOMETRY SYSTEM



SBM-3P
PLANETARY SYSTEM



**SBM HEAVY
SERIES**
LINEAR SYSTEM
PLANETARY SYSTEM



PRM SERIES

BROWSE THE
CATALOG BY
SCANNING THE
QR CODE.



PRM ECONOMIC SERIES PLATE ROLLING MACHINES



PRM MINI SERIES PLATE ROLLING MACHINES





BROWSE THE
CATALOG BY
SCANNING THE
QR CODE.

DRILLING MACHINE
DRL-B3 ▶

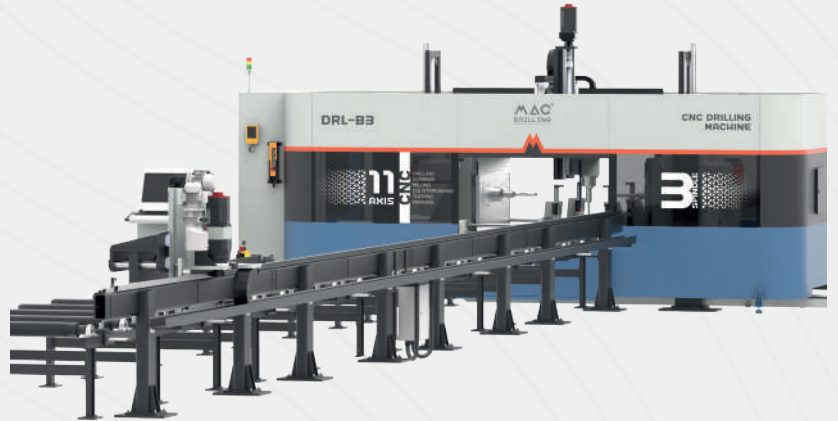

DRILLING MACHINE
◀ **DRL-B1**

DRILLING MACHINE
DRL-F 1500 ▶

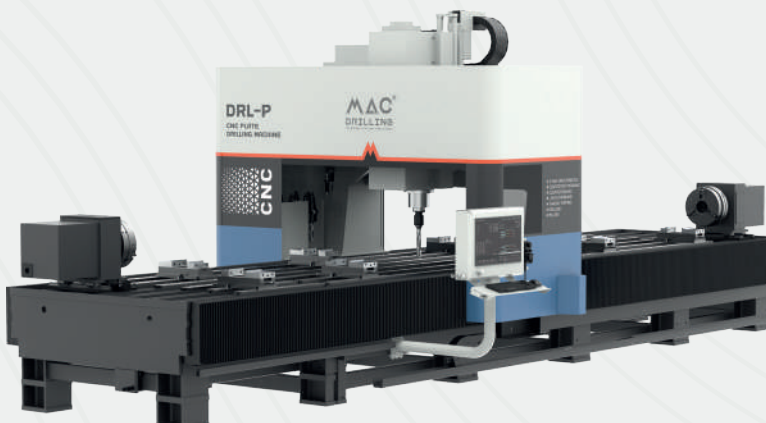

DRILLING MACHINE
◀ **DRL-P**

PBM-TH34

BENDING AND STRAIGHTENING MACHINE



9 AXIS

PBM-S

“S” SYSTEM REVERSE ANGLE PROFILE AND PIPE BENDING MACHINE

PBM-V1000

VARIABLE GEOMETRY PROFILE AND PIPE BENDING MACHINE

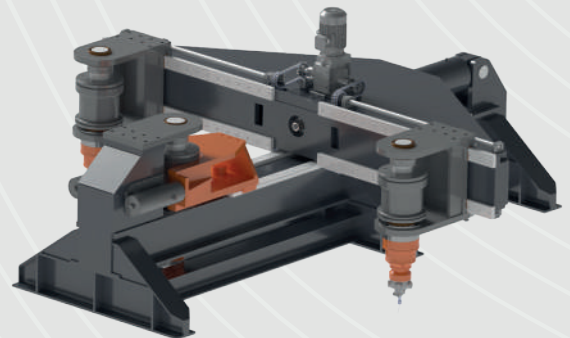

PSM-42

PROFILE AND PIPE BENDING MACHINE



BROWSE THE
CATALOG BY
SCANNING THE
QR CODE.





ABOUT US

MAC Machines, a brand of Mac Machines Diş Ticaret A.Ş., brings over 30 years of expertise in metal processing machinery. Operating from a state-of-the-art 10,000 m² facility, we specialize in manufacturing high-precision profile and sheet bending machines, engineered for durability, efficiency, and technological advancement.

Committed to excellence, our machines incorporate updatable software and modern control systems, ensuring seamless integration with evolving industry needs. Every product undergoes rigorous R&D and stringent quality control processes, fully compliant with ISO and CE standards. Serving industries such as construction, maritime and aviation. We deliver tailored solutions that enhance productivity and operational efficiency worldwide.

PRODUCTS AND SERVICES

At MAC Machines, our commitment extends beyond manufacturing, we prioritize long-term partnerships through exceptional after-sales support. Our dedicated team of experts is always available to provide prompt and effective technical assistance, ensuring uninterrupted workflow for our clients. By standing alongside our customers at every stage, we go beyond being a supplier to become a trusted solutions partner, dedicated to maximizing efficiency and customer satisfaction.



INSTALLATION

Our machines are installed at locations chosen by our customers. Delivery is completed after all tests and quality checks.







TRAINING

Our experts provide detailed training on machine operation. Every step is explained to ensure efficient use.



AFTER-SALES SUPPORT

Our team is always ready to assist. We respond quickly to any questions or issues. Customer satisfaction is our priority.

-  /mac_machines
-  /company/macmachines
-  @Mac-Machinery
-  /mac_machines



SCAN FOR OUR WEBSITE

Başköy Mah. 642. İsimsiz Sk. No:1 Nilüfer/BURSA

Phone: +90 224 449 02 02

E-Mail: info@macmachines.com

Website: www.macmachines.com

REF: 001/2025/03